

# Pyxis<sup>®</sup>

## HM-500 Oil-In-Water Inline Sensor User Manual



Water Professionals Deserve Better Tools.  
[www.pyxis-lab.com](http://www.pyxis-lab.com)

# HM-500 Series Oil-In-Water Inline Sensors User Manual

January 29, 2021  
Rev. 4.52

**Pyxis Lab, Inc.**  
1729 Majestic Dr. Suite 5  
Lafayette, CO 80026 USA  
[www.pyxis-lab.com](http://www.pyxis-lab.com)

## Table of Contents

<b>1</b>	<b>Introduction</b>	<b>2</b>
1.1	Main Features . . . . .	3
<b>2</b>	<b>Specifications</b>	<b>3</b>
<b>3</b>	<b>Unpacking Instrument</b>	<b>5</b>
3.1	Standard Accessories . . . . .	5
3.2	Optional Accessories . . . . .	6
<b>4</b>	<b>Installation</b>	<b>7</b>
4.1	HM-500/510/520 Piping . . . . .	7
4.2	HM-500SS/510SS/520SS Piping . . . . .	8
4.3	Wiring . . . . .	9
4.4	Connecting via Bluetooth . . . . .	9
4.5	Connecting via USB . . . . .	10
<b>5</b>	<b>Setup and Calibration with uPyxis® Mobile App</b>	<b>10</b>
5.1	Download uPyxis® Mobile App . . . . .	11
5.2	Connecting to uPyxis® Mobile App . . . . .	12
5.3	Calibration Screen and Reading . . . . .	12
5.4	Diagnosis Screen . . . . .	14
5.5	Device Info Screen . . . . .	15
<b>6</b>	<b>Setup and Calibration with uPyxis® Desktop App</b>	<b>15</b>
6.1	Install uPyxis® Desktop App . . . . .	16
6.2	Connecting to uPyxis® Desktop App . . . . .	17
6.3	Information Screen . . . . .	18
6.4	Calibration Screen . . . . .	18
6.5	Diagnosis Screen . . . . .	20
<b>7</b>	<b>Outputs</b>	<b>20</b>
7.1	4–20mA Output Setup . . . . .	20
7.2	Adjusting 4–20mA Span . . . . .	21
7.3	Communication using Modbus RTU . . . . .	21
<b>8</b>	<b>Sensor Maintenance and Precaution</b>	<b>22</b>
8.1	Methods to Cleaning the HM-500 Series Sensor . . . . .	22
8.2	Storage . . . . .	23
<b>9</b>	<b>Troubleshooting</b>	<b>23</b>
<b>10</b>	<b>Contact Us</b>	<b>23</b>

## **Warranty Information**

### **Confidentiality**

The information contained in this manual may be confidential and proprietary and is the property of Pyxis Lab, Inc. Information disclosed herein shall not be used to manufacture, construct, or otherwise reproduce the goods described. Information disclosed herein shall not be disclosed to others or made public in any manner without the express written consent of Pyxis Lab, Inc.

### **Standard Limited Warranty**

Pyxis Lab warrants its products for defects in materials and workmanship. Pyxis Lab will, at its option, repair or replace instrument components that prove to be defective with new or remanufactured components (i.e., equivalent to new). The warranty set forth is exclusive and no other warranty, whether written or oral, is expressed or implied.

### **Warranty Term**

The Pyxis warranty term is thirteen (13) months ex-works. In no event shall the standard limited warranty coverage extend beyond thirteen (13) months from original shipment date.

### **Warranty Service**

Damaged or dysfunctional instruments may be returned to Pyxis for repair or replacement. In some instances, replacement instruments may be available for short duration loan or lease.

Pyxis warrants that any labor services provided shall conform to the reasonable standards of technical competency and performance effective at the time of delivery. All service interventions are to be reviewed and authorized as correct and complete at the completion of the service by a customer representative, or designate. Pyxis warrants these services for 30 days after the authorization and will correct any qualifying deficiency in labor provided that the labor service deficiency is exactly related to the originating event. No other remedy, other than the provision of labor services, may be applicable.

Repair components (parts and materials), but not consumables, provided during a repair, or purchased individually, are warranted for 90 days ex-works for materials and workmanship. In no event will the incorporation of a warranted repair component into an instrument extend the whole instrument's warranty beyond its original term.

### **Warranty Shipping**

A Repair Authorization (RA) Number must be obtained from Pyxis Technical Support before any product can be returned to the factory. Pyxis will pay freight charges to ship replacement or repaired products to the customer. The customer shall pay freight charges for returning products to Pyxis. Any product returned to the factory without an RA number will be returned to the customer. To receive an RMA you can generate a request on our website at <https://pyxis-lab.com/request-tech-support/>.

### **Pyxis Technical Support**

Contact Pyxis Technical Support at +1 (866) 203-8397, [service@pyxis-lab.com](mailto:service@pyxis-lab.com), or by filling out a request for support at <https://pyxis-lab.com/request-tech-support/>.

## 1 Introduction

The Pyxis HM-500 Series sensor measures the concentration of multiple oils in water utilizing fluorescence methodology at 365 nm wavelength and 410 nm excitation. The HM-500 Series sensor is uniquely designed with extra photo-electric components that also monitor the color and turbidity of the sample water. This proprietary feature enables the HM-500 Series sensor to automatically compensate for color and turbidity in the water sample eliminating interference commonly associated with real-world samples. The HM-500 Series sensor has a short fluidic channel and can be easily cleaned. The fluidic and optical arrangement of the HM-500 Series sensor are designed to overcome shortcomings associated with other fluorometers that have a distal sensor surface or a long, narrow fluidic cell. Traditional inline fluorometers are susceptible to color/turbidity interference and fouling and can also be very difficult to clean. These unique features of the HM-500 Series sensor provide a level of accuracy far greater than conventional inline oil in water sensors and also enables the user to conduct inline sensor cleanliness diagnostics as a predictive value.

Oil is a complex mixture of organic compounds. The term “oil” can be referred to as a range of different classes of chemical compounds, such as vegetable oil and petroleum oil. Almost all oil substances fluoresce under UV or near UV excitation in a different degree because invariably, all oil contains aromatic or other fluorescent compounds. Oil-in-water analysis by fluorescence is a widely used field-testing method but is fundamentally different from other wet chemistry methods, which are highly accurate but extremely time consuming and done off-line. Commonly used alternative methods include the following:

1. EPA 1664 gravimetric method measures the amount of oil extracted to a solvent by weight.
2. The Infrared method (ASTD D7678) measures the absorption of oil extracted to cyclohexane in the range of 1370–1380  $\text{cm}^{-1}$  by methyl group in the oil, using an IR spectrophotometer to qualify the oil concentration.

Due to the HM-500 Series sensor utilizing the fluorescent signature of the oil in water, the concentrations initially measured by the sensor for a given water sample “may” agree with each other in a relative sense, but this is not always a guarantee. The HM-500 Series is designed to be calibrated to agree with the oil-in-water concentration from a given oil type determined by commonly used methods. The calibration of the HM-500 Series sensor should be initially done by the user with an actual prepared oil-in-water standard, within the detection range of the sensor itself. Once calibrated to the prepared oil-in-water standard, the HM-500 Series sensor can be used to “measure” a synthetic Pyxis Oil-In-Water Secondary Standard Solution to determine its “equivalent value”. This secondary standard and its equivalent value can then be used in the future for sensor calibrations, as a more stable and easier method of sensor calibration versus preparing the actual oil-in-water standard each time. Details are explained on this process in the calibration sections of this manual.

Each HM-500 Series sensor is also provided with the standard ST-001 Tee Assembly for rapid installation in commonly used piping platforms. The ST-001 has two 3/4” female NPT ports in both threaded and straight socket formats. Pyxis Lab also offers 2” and 3” Tee formats for larger inline installations as well as the MA-102S Submersion Adapter for submersed applications. The HM-500 Series sensor offers both 4–20mA and RS-485 Modbus outputs for rapid connection to any microprocessor controller; PLC or DCS. When used with the MA-WB Bluetooth Adapter, the HM-500 Series sensor may be accessed wirelessly for cleaning and calibration using the **uPyxis**® Mobile or Desktop App. Alternatively, if power supply is limited from the receiving controller, users may utilize a Pyxis PowerPack auxiliary box. PowerPack is offered in both 1- and 4-channel platforms providing 24 VDC power supply to any Pyxis inline sensor as well as 4–20mA signal passthrough and Bluetooth connectivity to all Pyxis sensors connected. See the **Unpacking Instrument** section for details.

## 1.1 Main Features

The HM-500 Series sensor includes the following main features:

- Easy calibration and Cleanliness Check using **uPyxis®** Mobile or Desktop App
- Automatic compensation for turbidity up to 150 NTU and color created by up to 10 ppm iron or equivalent to 10 ppm iron/humic acid
- Diagnostic information (sensor fouling, color or turbidity over range, failure modes) are available in **uPyxis®** App or via Modbus RTU
- Easy removal from the system for cleaning & calibration without the need for any tools
- Wireless access via a MA-WB Bluetooth Adapter or PowerPack and **uPyxis®** App
- Easy inline installation using ST-001 Tee Assembly provided
- MA-102S Submersion Adapter Kit available for submersed application

## 2 Specifications

**Table 1.** HM-500 Series Specifications

Specifications*	HM-500	HM-510	HM-520
Part Number (P/N)	52101	52102	52106
Oil-in-Water Range †	0.1–10 ppm	0.5–1000 ppm	0.5–100 ppm
Oil-in-Water Accuracy	0.1 ppm or ≤3% of reading		
Method	UV-Fluorescence		
Emission Wavelength	365 nm		
Excitation Wavelengths	410 nm/470 nm		
Outputs	4–20mA Analog Output, RS-485 Digital Output with Modbus protocol		
Installation	Custom tee assembly (P/N: ST-001) with 3/4" FNPT socket & threaded ports		
Cable Length	5 ft with IP67 connectors		
Power Supply	22–26 VDC, 65 mA		
Dimension (L × D)	6.8 × 1.44 inch (172.7 × 36.6 mm)		
Weight	0.37 lbs (170 g)		
Material	CPVC		
Operational Temperature	40–104 °F (4–40 °C)		
Storage Temperature	20–140 °F (-7–60 °C)		
Pressure	Up to 100 psi (0.7 MPa)		
Enclosure Rating	IP67		
Regulation	CE		

\* With Pyxis's continuous improvement policy, these specifications are subject to change without notice.

† The oil-in-water concentration range is based on a marine diesel oil standard.

**Table 2.** Stainless Steel HM-500 Series Specifications

Specifications*	HM-500SS	HM-510SS	HM-520SS
Part Number (P/N)	52114	52125	52126
Oil-in-Water Range †	0.1–10 ppm	0.5–1000 ppm	0.5–100 ppm
Oil-in-Water Accuracy	0.1 ppm or ≤3% of reading		
Method	UV-Fluorescence		
Emission Wavelength	365 nm		
Excitation Wavelengths	410 nm/470 nm		
Outputs	4–20mA Analog Output, RS-485 Digital Output with Modbus protocol		
Installation	3/4" FNPT threaded ports		
Cable Length	5 ft with IP67 connectors		
Power Supply	22–26 VDC, 65 mA		
Dimension	See Figure 4		
Weight	2.5 lbs (1130 g)		
Material	304 Stainless Steel		
Operational Temperature	40–104 °F (4–40 °C)		
Storage Temperature	20–140 °F (-7–60 °C)		
Pressure	Up to 290 lbs (2.0 MPa)		
Enclosure Rating	IP67		
Regulation	CE		

\* With Pyxis's continuous improvement policy, these specifications are subject to change without notice.

† The oil-in-water concentration range is based on a marine diesel oil standard.

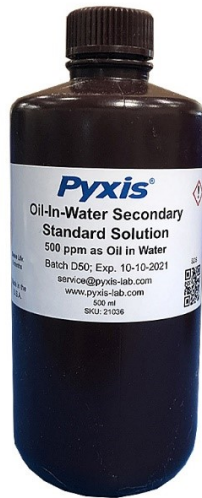

**Figure 1.** Oil-in-Water Secondary Standard (OIW-500)

**Table 3.** Oil-in-Water Secondary Standard (OIW-500) Specifications

Specification	Oil-in-Water Secondary Standard (OIW-500)
Part Number (P/N)	20158
Oil in Water*	500 ppm
Container	16 oz/500 mL Nalgene Amber Narrow Mouth Sample Bottle
Shelf Life	6 months
Net Volume	510±10 mL
Net Weight	510±10 g

\* Pyxis OIW-500 is a synthetic standard which will read 500 ppm by a factory calibrated HM-510 sensor. This product must be diluted for use with HM-500 and HM-520 inline sensors to measure within their range. Once the HM-500 Series sensor is calibrated to a known oil-in-water standard, you may use the equivalent value of the prepared oil-in-water secondary standard for future sensor calibrations. See calibration sections for details.

### 3 Unpacking Instrument

Remove the instrument and accessories from the shipping container and inspect each item for any damage that may have occurred during shipping. Verify that all accessory items are included. If any item is missing or damaged, please contact Pyxis Lab Customer Service at [service@pyxis-lab.com](mailto:service@pyxis-lab.com).

#### 3.1 Standard Accessories

- Tee Assembly 3/4" NPT (1x Tee, O-ring, and Nut) P/N: ST-001

**\*NOTE\*** *ST-001 is not included for HM-500SS, HM-510SS, or HM-520SS*

- 7-Pin Female Adapter/Flying Leads Cable (2 ft) P/N: MA-1100
- User Manual available online at <https://pyxis-lab.com/support/>



### 3.2 Optional Accessories

The following optional accessories can be ordered from Pyxis Customer Service ([order@pyxis-lab.com](mailto:order@pyxis-lab.com)) or Pyxis E-Store at <https://pyxis-lab.com/shop/>.











 <b>PYXIS INLINE SENSOR ACCESSORIES - SELECT*A*GUIDE</b> 		
Accessory Name/Description	Part Number	Photo
Pyxis OIW-500 <i>(Synthetic Oil in Water Secondary Standard 500ppm/500mL)</i>	21036	
0.75" NPT Inline Sensor Tee Assembly <i>(All ST Series Sensors)</i>	50704	
2.0" NPT Inline Sensor Tee Assembly <i>(All ST Series Sensors)</i>	50756	
3.0" NPT Inline Sensor Tee Assembly <i>(All ST Series Sensors)</i>	50775	
ST-002 Inline Sensor Removal PLUG <i>(Allows ST Sensor Removal)</i>	ST-002	
ST Series Sensor Tee Replacement O-Ring <i>(All ST Series Tee's)</i>	MA-150	
ST Series Submersion Adapter Kit <i>(Submersible Kit for all ST-Series Sensors)</i>	MA-102S	
MA-WB Bluetooth Adapter for All ST Series Sensors <i>(4-20mA &amp; RS-485)</i>	MA-WB	
MA-485 USB Adapter for All ST Series Sensors <i>(4-20mA RS-485)</i>	MA-485	
Bluetooth PC to Handheld Adapter <i>(For uPyxis Firmware Updates)</i>	MA-NEB	
PowerPack 1 <i>(Single Channel Power Supply w/Bluetooth)</i>	MA-BLE-1	
PowerPack 4 <i>(Four Channel Power Supply w/Bluetooth)</i>	MA-BLE-4	
MA-1100 <i>(24' Flying Lead Cable for All ST Sensors)</i>	MA-1100	
MA-C10 <i>(10' Extension Cable for All ST Sensors)</i>	50738	
MA-C50 <i>(50' Extension Cable for All ST Sensors)</i>	50705	

Figure 2.

## 4 Installation

### 4.1 HM-500/510/520 Piping

The provided ST-001 Tee Assembly can be connected to a pipe system through the 3/4" female ports, either socket or NPT threaded. To properly install the HM-500 Series sensor into the ST-001 Tee Assembly, follow the steps below:

1. Insert the provided O-ring into the O-ring groove on the tee.
2. Insert the HM-500/510/520 sensor into the tee.
3. Tighten the tee nut onto the tee to form a water-tight, compression seal.

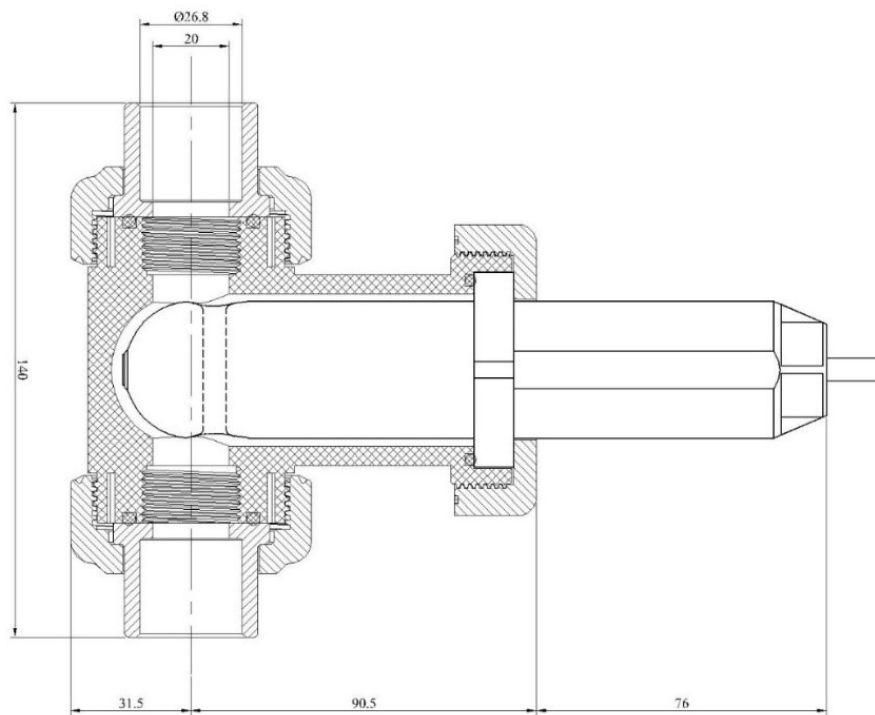

**Figure 3.** Dimension of the HM-500/510/520 sensor and the ST-001 Tee Assembly (mm)

## 4.2 HM-500SS/510SS/520SS Piping

The stainless steel sensor has 3/4" female NPT threaded ports on the sensor itself and therefore does not require a custom tee assembly. It is recommended that two 3/4" NPT to 1/4" tubing adapters are used to connect the sensor to the sampling system. Sample water entering the sensor must be cooled down to below 104 °F (40 °C). The sensor can be held by a 1.75-inch pipe clamp or mounted to a panel with four 1/4"-28 bolts. See Figure 4 for stainless steel sensor dimensions.

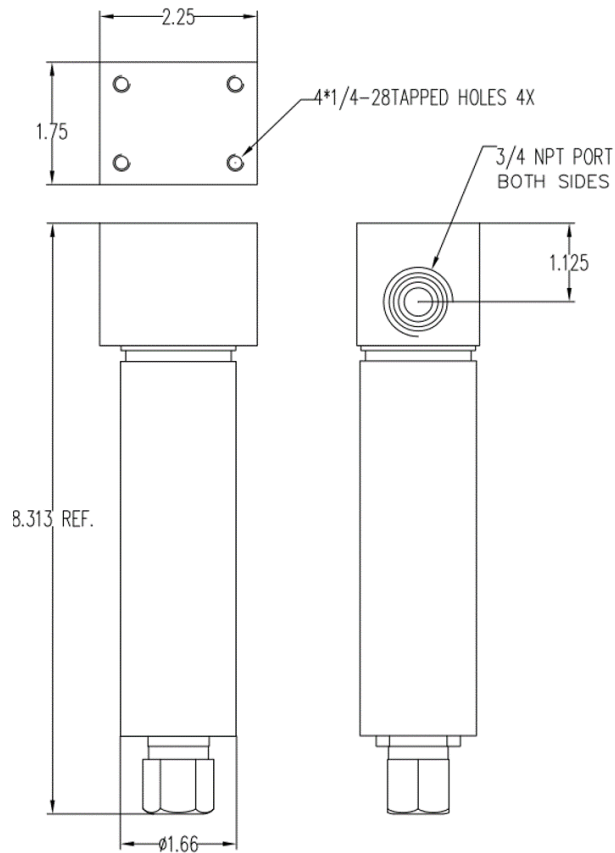

**Figure 4.** Dimension of the HM-500SS/510SS/520SS (inch)

### 4.3 Wiring

If the power ground terminal and the negative 4–20mA terminal in the controller are internally connected (non-isolated 4–20mA input), it is unnecessary to connect the 4–20mA negative wire (green) to the 4–20mA negative terminal in the controller. If a separate DC power supply other than that from the controller is used, make sure that the output from the power supply is rated for 22–26 VDC @ 65mA.

**\*NOTE\*** *The negative 24V power terminal (power ground) and the negative 4–20mA terminal on the HM-500 Series sensor are internally connected.*

Follow the wiring table below to connect the HM-500 Series sensor to a controller:

**Table 4.**

Wire Color	Designation
Red	24V +
Black	24V Power ground
White	4–20mA +
Green*	4–20mA -
Blue	RS-485 A
Yellow	RS-485 B
Clear	Shield, earth ground

\* Internally connected to the power ground

### 4.4 Connecting via Bluetooth

A Bluetooth adapter (P/N: MA-WB) can be used to connect a HM-500 Series sensor to a smart phone with the **uPyxis®** Mobile App or a computer with the **uPyxis®** Desktop App. The power should be sourced from a 24 VDC power terminal of a controller. If a controller is not available, the user may also use Pyxis PowerPACK-1 or PowerPACK-4 as an alternative to both an external power supply and a Bluetooth adapter. PowerPACK from Pyxis Lab offers external power, Input/Output signal, and Bluetooth connectivity.

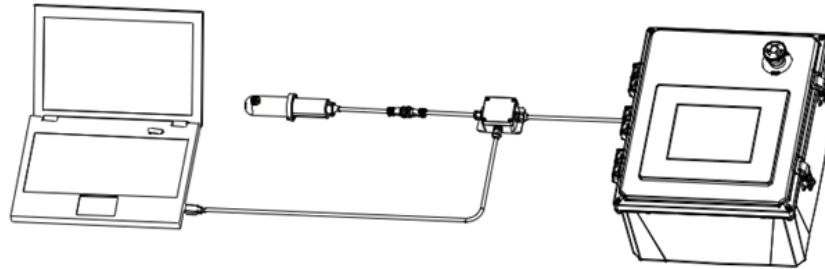

**Figure 5.** Bluetooth connection to HM-500 Series sensor

#### 4.5 Connecting via USB

A USB-RS485 adapter (P/N: MA-485) can be used to connect a HM-500 Series sensor to a computer with the uPyxis® Desktop app.

**\*NOTE\*** Using non-Pyxis USB-RS485 adapters may result in permanent damage of the HM-500 Series sensor communication hardware.



**Figure 6.** USB connection to HM-500 Series sensor

### 5 Setup and Calibration with uPyxis® Mobile App

The HM-500 Series sensor should be initially calibrated with a two-point (zero + slope) procedure using a deionized (DI) water sample (zero) and a prepared solution (slope) containing the actual oil-in-water desired. For the most accurate measurement in low range concentrations of oil-in-water, the two-point calibration is required. The HM-500 Series sensor can be also calibrated by a one-point procedure while in service. However, a Cleanliness Check of the HM-500 Series sensor should be conducted first to determine if the sensor is clean enough to be calibrated (see the **Mobile Diagnosis Screen** section).

**\*NOTE\*** Direct sunlight or indoor light on the HM-500 Series sensor should be avoided, although it is not necessary to completely shield the HM-500 Series sensor from the ambient light during both the zero and slope calibrations.

### 5.1 Download uPyxis® Mobile App

Download uPyxis® Mobile App from [Apple App Store](#) or [Google Play](#).



**Figure 7.** uPyxis® Mobile App installation

## 5.2 Connecting to uPyxis® Mobile App

Connect the HM-500 Series sensor to a mobile smart phone according to the following steps:

1. Open **uPyxis®** Mobile App.
2. On **uPyxis®** Mobile App, pull down to refresh the list of available Pyxis devices.
3. If the connection is successful, the HM-500 Series and its Serial Number (SN) will be displayed (Figure 8).
4. Press on the **HM-500 Series sensor image**.

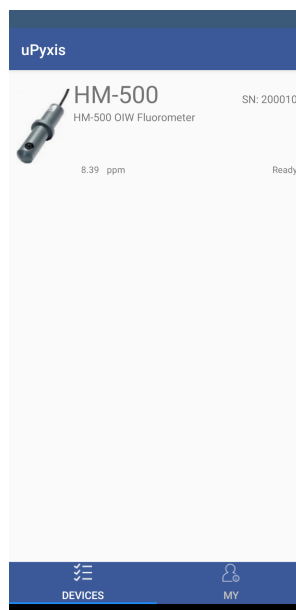

Figure 8.

## 5.3 Calibration Screen and Reading

When connected, the **uPyxis®** Mobile App will default to the **Calibration** screen (Figure 9). From the **Calibration** screen, you can perform calibrations by pressing on **Zero Calibration**, **Slope Calibration**, and **4–20mA Span**. Follow the screen instructions for each calibration step.

### 5.3.1 Required Initial Slope Calibration

For the first calibration, it is required to prepare an oil-in-water calibration solution using the desired oil with a concentration within the range of the HM-500 Series sensor being used (i.e. HM-500 should be calibrated with a user-prepared, oil-in-water solution between 1 and 10 ppm). The user-prepared, oil-in-water calibration solution can be made by mixing a sample of the oil with DI water to develop a known ppm level. The concentration of this solution should be verified by standard wet chemistry methods or using Pyxis HM-900 Handheld Oil-in-Water Analyzer.

**\*NOTE\*** *If the user wants to measure a different oil, then use this calibration procedure for the first calibration of the new desired oil.*

### 5.3.2 General Slope Calibration

The slope value of the HM-500 Series sensor can be calibrated in two ways:

1. By preparing an oil-in-water calibration solution as described in the **Required Initial Slope Calibration** section, or
2. By using the Pyxis Oil-in-Water Secondary Standard (OIW-500) described below.

As an alternative to preparing a real oil-in-water calibration standard for future calibrations, the Pyxis OIW-500 synthetic Oil-in-Water Secondary Standard (P/N: 20158) can be used. OIW-500 components are highly stable and far easier to use for rapid calibration compared to a real oil-in-water solution. The OIW-500 calibration standard offers a 500 ppm equivalent oil-in-water concentration recognized by the fluorescent signature of the HM-500 Series sensor. Due to the different oil-in-water concentration ranges in the HM-500 Series sensors, follow the guidelines below to properly prepare the OIW-500 solution for each sensor:

- HM-500: Prepare a 5 ppm oil-in-water solution by mixing 198 mL of DI Water with 2 mL of OIW-500.
- HM-510: No preparation required. Use OIW-500 without modification.
- HM-520: Prepare a 50 ppm oil-in-water solution by mixing 180 mL of DI Water to 20 mL of OIW-500.

**\*NOTE\*** For the HM-500 sensor, it is recommended to prepare a 5 ppm oil-in-water solution prior to each calibration. At this low concentration, the solution has a reduced long-term stability and shelf-life.

Once a OIW-500-based solution is prepared, submerge the HM-500 Series sensor in the prepared solution and use the **Calibration** screen of the **uPyxis®** Mobile App to read the current ppm value from the sensor. Record this ppm value. This ppm value should be used as the slope calibration value for future calibrations when using the prepared OIW-500 Secondary Standard.



Figure 9.



## 5.4 Diagnosis Screen

From the **Diagnosis** screen, you can set the diagnosis condition as well as **Export & Upload**. This feature may be used for technical support when communicating with [service@pyxis-lab.com](mailto:service@pyxis-lab.com).

To perform a sensor Cleanliness Check, first select the **Diagnosis Condition** which defines the fluid type that the HM-500 Series sensor is currently measuring, then press **Cleanliness Check**. If the sensor is clean, a green **Clean** message will be shown. If the sensor is partially fouled, a yellow **Becoming Dirty** message will be shown. If the sensor is severely fouled, a red **Dirty** message will be shown. In this case, follow the procedure in the **Methods to Cleaning the HM-500 Series Sensor** section of this manual.

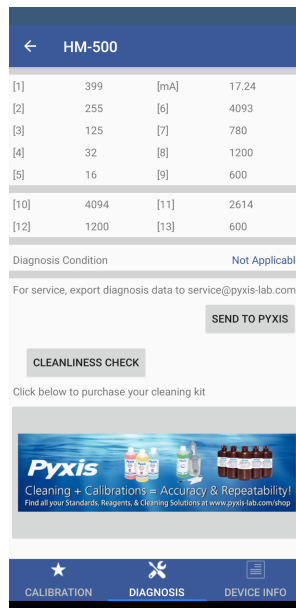
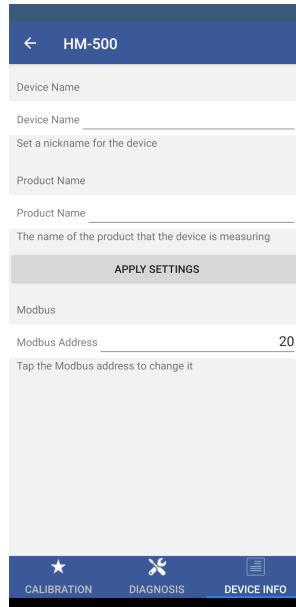

Figure 10.

## 5.5 Device Info Screen

From the **Device Info** screen. You can name the Device or Product.



The screenshot shows the 'HM-500' device info screen. At the top, there is a back arrow and the device ID 'HM-500'. Below this, there are two sections for naming: 'Device Name' with a text input field and a label 'Set a nickname for the device', and 'Product Name' with a text input field and a label 'The name of the product that the device is measuring'. A grey 'APPLY SETTINGS' button is positioned between these two sections. Below the button is the 'Modbus' section, which includes a 'Modbus Address' field with the value '20' and a label 'Tap the Modbus address to change it'. At the bottom, there is a navigation bar with three icons: a star for 'CALIBRATION', a wrench for 'DIAGNOSIS', and a document for 'DEVICE INFO'.

Figure 11.

## 6 Setup and Calibration with uPyxis® Desktop App

The HM-500 Series sensor should be initially calibrated with a two-point (zero + slope) procedure using a deionized (DI) water sample (zero) and a prepared solution (slope) containing the actual oil-in-water desired. For the most accurate measurement in low range concentrations of oil-in-water, the two-point calibration is required. The HM-500 Series sensor can be also calibrated by a one-point procedure while in service. However, a Cleanliness Check of the HM-500 Series sensor should be conducted first to determine if the sensor is clean enough to be calibrated (see the **Desktop Diagnosis Screen** section).

**\*NOTE\*** *Direct sunlight or indoor light on the HM-500 Series sensor should be avoided, although it is not necessary to completely shield the HM-500 Series sensor from the ambient light during both the zero and slope calibrations.*

## 6.1 Install uPyxis® Desktop App

Download the latest version of **uPyxis®** Desktop software package from: <https://pyxis-lab.com/upyxis/> this setup package will download and install the Microsoft.Net Framework 4.5 (if not previously installed on the PC), the USB driver for the USB-Bluetooth adapter (MA-NEB), the USB-RS485 adapter (MA-485), and the main **uPyxis®** Desktop application. Double click the **uPyxis.Setup.exe** file to install.

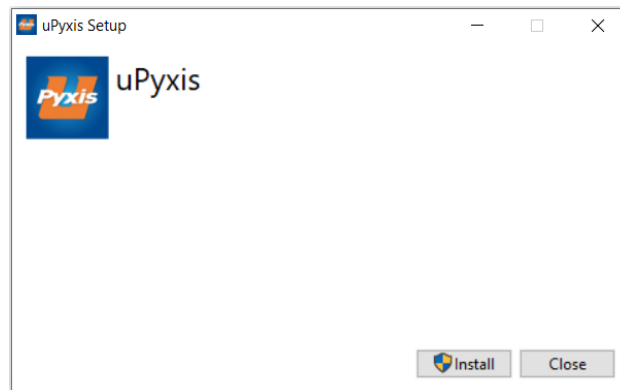

**Figure 12.** uPyxis® Desktop App installation

Click **Install** to start the installation process. Follow the screen instructions to complete the USB driver and **uPyxis®** installation.

## 6.2 Connecting to uPyxis® Desktop App

Connect the HM-500 Series sensor to a Windows computer using either a Bluetooth/USB adapter (P/N: MA-NEB) or a USB-RS485 adapter (P/N: MA-485) according to the following steps:

1. Plug the Bluetooth/USB adapter or USB-RS485 adapter into a USB port in the computer.
2. Launch **uPyxis®** Desktop App.
3. On **uPyxis®** Desktop App, click Device → **Connect via USB-Bluetooth** or **Connect via USB-RS485** (Figure 13).
4. If the connection is successful, the HM-500 Series and its Serial Number (SN) will be displayed in the left pane of the **uPyxis®** window.

**\*NOTE\*** After the sensor and Bluetooth is powered up, it may take up to 10 seconds for the adapter to establish the wireless signal for communication.

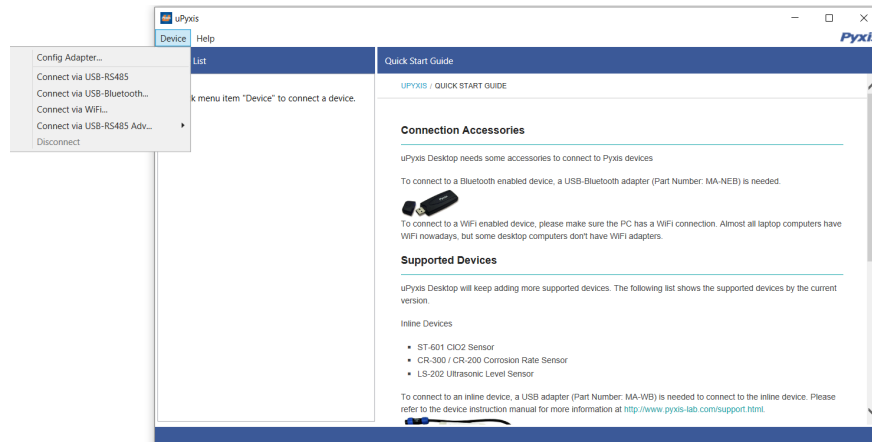

Figure 13.

### 6.3 Information Screen

Once connected to the device, a picture of the device will appear on the top left corner of the window and the uPyxis® Desktop App will default to the **Information** screen. On the **Information** screen you can set the information description for **Device Name** and **Product Name**, then click **Set** to save.

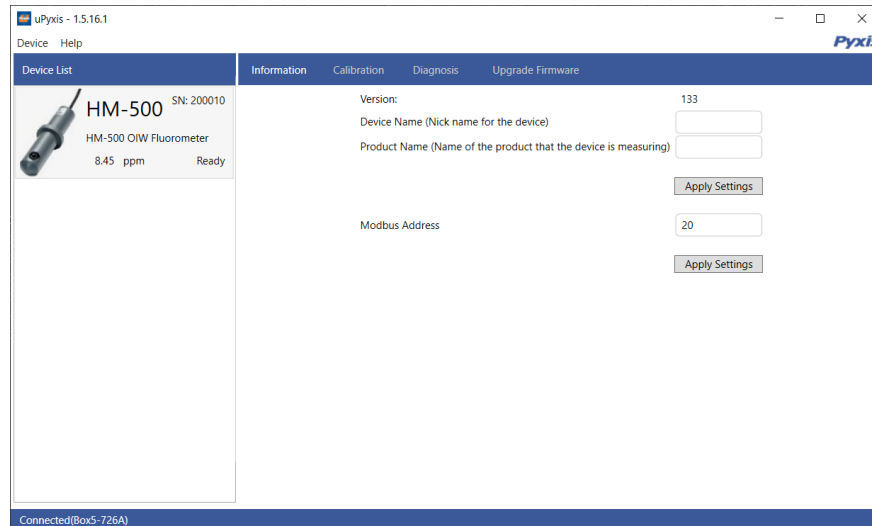

Figure 14.

### 6.4 Calibration Screen

To calibrate the device, click on **Calibration**. On the **Calibration** screen (Figure 15) there are three calibration buttons, **Zero Calibration**, **Slope Calibration**, and **4–20mA Span**. Follow the screen instructions for each calibration step. The screen also displays the reading of the device. The reading refresh rate is every 4 seconds.

#### 6.4.1 Required Initial Slope Calibration

For the first calibration, it is required to prepare an oil-in-water calibration solution using the desired oil with a concentration within the range of the HM-500 Series sensor being used (i.e. HM-500 should be calibrated with a user-prepared, oil-in-water solution between 1 and 10 ppm). The user-prepared, oil-in-water calibration solution can be made by mixing a sample of the oil with DI water to develop a known ppm level. The concentration of this solution should be verified by standard wet chemistry methods or using Pyxis HM-900 Handheld Oil-in-Water Analyzer.

**\*NOTE\*** *If the user wants to measure a different oil, then use this calibration procedure for the first calibration of the new desired oil.*

## 6.4.2 General Slope Calibration

The slope value of the HM-500 Series sensor can be calibrated in two ways:

1. By preparing an oil-in-water calibration solution as described in the **Required Initial Slope Calibration** section, or
2. By using the Pyxis Oil-in-Water Secondary Standard (OIW-500) described below.

As an alternative to preparing a real oil-in-water calibration standard for future calibrations, the Pyxis OIW-500 synthetic Oil-in-Water Secondary Standard (P/N: 20158) can be used. OIW-500 components are highly stable and far easier to use for rapid calibration compared to a real oil-in-water solution. The OIW-500 calibration standard offers a 500 ppm equivalent oil-in-water concentration recognized by the fluorescent signature of the HM-500 Series sensor. Due to the different oil-in-water concentration ranges in the HM-500 Series sensors, follow the guidelines below to properly prepare the OIW-500 solution for each sensor:

- HM-500: Prepare a 5 ppm oil-in-water solution by mixing 198 mL of DI Water with 2 mL of OIW-500.
- HM-510: No preparation required. Use OIW-500 without modification.
- HM-520: Prepare a 50 ppm oil-in-water solution by mixing 180 mL of DI Water to 20 mL of OIW-500.

**\*NOTE\*** For the HM-500 sensor, it is recommended to prepare a 5 ppm oil-in-water solution prior to each calibration. At this low concentration, the solution has a reduced long-term stability and shelf-life.

Once a OIW-500-based solution is prepared, submerge the HM-500 Series sensor in the prepared solution and use the **Calibration** screen of the **uPyxis®** Mobile App to read the current ppm value from the sensor. Record this ppm value. This ppm value should be used as the slope calibration value for future calibrations when using the prepared OIW-500 Secondary Standard.

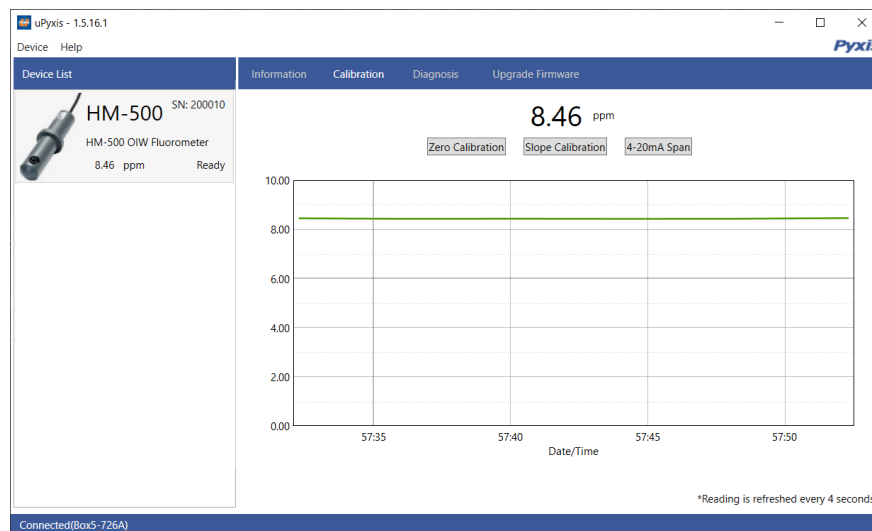

Figure 15.

## 6.5 Diagnosis Screen

After the device has been calibrated and installation has been completed, to check diagnosis, click on **Diagnosis**. When in the **Diagnosis** screen you can view the Diagnosis Condition of the device. This feature may be used for technical support when communicating with [service@pyxis-lab.com](mailto:service@pyxis-lab.com).

To perform a sensor Cleanliness Check, first select the **Diagnosis Condition** which defines the fluid type that the HM-500 Series sensor is currently measuring, then click **Cleanliness Check**. If the sensor is clean, a green **Clean** message will be shown. If the sensor is partially fouled, a yellow **Becoming Dirty** message will be shown. If the sensor is severely fouled, a red **Dirty** message will be shown. In this case, follow the procedure in the **Methods to Cleaning the HM-500 Series Sensor** section of this manual.

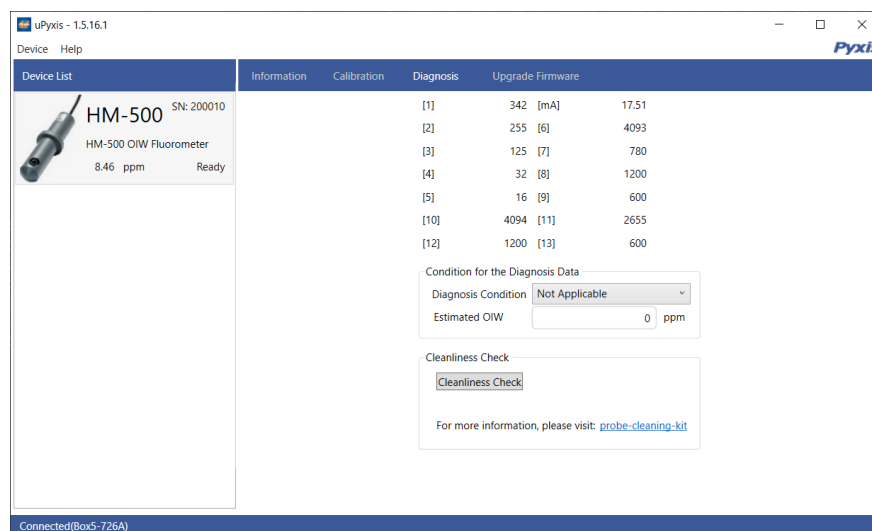

Figure 16.

## 7 Outputs

### 7.1 4–20mA Output Setup

The 4–20mA output of the HM-500 and HM-500SS sensor is scaled as:

- Oil-in-Water:
  - 4 mA = 0 ppm
  - 20 mA = 10 ppm

The 4–20mA output of the HM-510 and HM-510SS sensor is scaled as:

- Oil-in-Water:
  - 4 mA = 0 ppm
  - 20 mA = 1000 ppm

The 4–20mA output of the HM-520 and HM-520SS sensor is scaled as:

- Oil-in-Water:
  - 4 mA = 0 ppm
  - 20 mA = 100 ppm

## 7.2 Adjusting 4–20mA Span

Users may adjust the output scale using 4–20mA Span to change the oil-in-water value corresponding to the 20 mA output via uPyxis®. For the uPyxis® Mobile App, press **4-20mA Span** found on the **Calibration and Reading Screen**, shown in Figure 17. For the uPyxis® Desktop App, click **4-20mA Span** found on the **Calibration Screen**, shown in Figure 18.

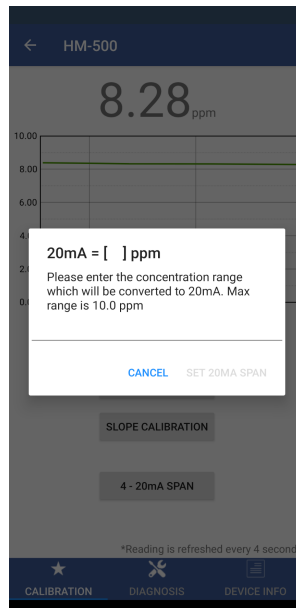

Figure 17.

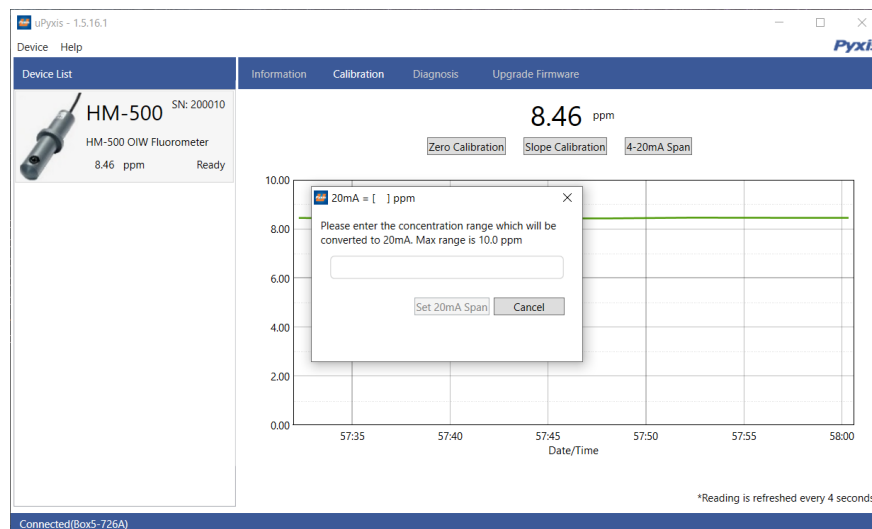

Figure 18.

## 7.3 Communication using Modbus RTU

The HM-500 Series is configured as a Modbus slave device. In addition to the oil-in-water ppm value, many operational parameters including warning and error messages are available via a Modbus RTU connection. Contact Pyxis Lab Technical Service ([service@pyxis-lab.com](mailto:service@pyxis-lab.com)) for more information.



## 8 Sensor Maintenance and Precaution

The HM-500 Series sensor is designed to provide reliable and continuous oil-in-water readings even when installed in moderately contaminated industrial waters. Although the optics are compensated for the effects of moderate fouling, heavy fouling will prevent the light from reaching the sensor, resulting in low readings and the potential for product overfeed if the HM-500 Series sensor is used as part of an automated control system. When used to control product dosing, it is suggested that the automation system be configured to provide backup to limit potential product overfeed, for example by limiting pump size or duration, or by alarming if the pumping rate exceeds a desired maximum limit.

The HM-500 Series sensor is designed to be easily removed, inspected, and cleaned if required. It is suggested that the HM-500 Series sensor be checked for fouling and cleaned/calibrated on a monthly basis. Heavily contaminated waters may require more frequent cleanings. Cleaner water sources with less contamination may not require cleaning for several months.

The need to clean the HM-500 Series sensor can be determined by the Cleanliness Check using either the **uPyxis®** Mobile App (see the **Mobile Diagnosis Screen** section) or the **uPyxis®** Desktop App (see the **Desktop Diagnosis Screen** section).

### 8.1 Methods to Cleaning the HM-500 Series Sensor

Any equipment in contact with industrial systems is subject to many potential foulants and contaminants. A small, soft bristle brush, Q-Tips cotton swab, or soft cloth may be used to safely clean the sensor housing and the quartz optical sensor channel. Deposits inside the sensor quartz tube can be cleaned using a prepared detergent-based cleaning solution and hot water. Prepare 200 mL of hot water (55–60 °C) with 10 mL of industrial degreasing detergent.

To clean the HM-500 Series sensor, soak the lower half of the sensor in 100 mL of the prepared cleaning solution for 10 minutes and gently scrub the quartz optical sensor channel. Rinse the HM-500 Series sensor with distilled water and then check for the flashing blue light inside the HM-500 Series sensor quartz tube. Use the Cleanliness Check via **uPyxis®** Mobile App (see the **Mobile Diagnosis Screen** section) or **uPyxis®** Desktop App (see the **Desktop Diagnosis Screen** section) to confirm that the HM-500 Series sensor is clean. Repeat the process as needed until the Cleanliness Check shows **Clean**.

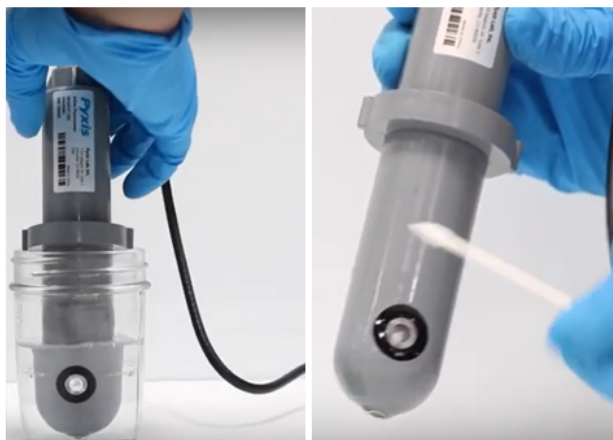

Figure 19. Cleaning of HM-500 Series Sensor

## 8.2 Storage

Avoid long term storage at temperature over 140 °F. In an outdoor installation, properly shield the HM-500 Series sensor from direct sunlight and precipitation.

## 9 Troubleshooting

If the HM-500 Series sensor output signal is not stable and fluctuates significantly, make an additional ground connection — connect the clear (shield, earth ground) wire to a conductor that contacts the sample water electrically such as a metal pipe adjacent to the HM-500 Series tee.

## 10 Contact Us

**Pyxis Lab, Inc**

1729 Majestic Dr. Suite 5

Lafayette, CO 80026 USA

[www.pyxis-lab.com](http://www.pyxis-lab.com)

Phone: +1 (866) 203-8397

Email: [service@pyxis-lab.com](mailto:service@pyxis-lab.com)